



CODE CLUB

Community Of Developing Engineers

YEAR: 2021-22





The Team





TECHNICAL DIYA MAKING

02-11-2021







ALUMNI DISCUSSION

13-11-2021









TRANSCENDENCE

19-11-2021





ATRIA
INSTITUTE OF TECHNOLOGY

Department
Of
CS&E

CODE
CLUB
presents

TRANSCENDENCE

ESCAPE ROOMS

TECH-A-THON

CODOLYSIS





Register @
<https://bit.ly/3DfyRQZ>

Win Exciting Gummies!

NOVEMBER 19TH, FRIDAY
11:00AM ONWARDS





ESCAPE ROOMS

BY CODE CLUB

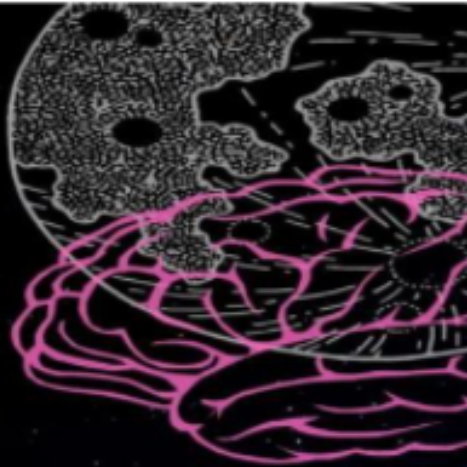

code club

Riddles | Ciphers
Puzzles | Brain-teasers
19 NOV 2021

SEMINAR HALL
11:00 AM
ONWARDS

For Further Enquiries:
Contact :Ruchita 8197044870 /
Vincent 7619367306







WINNER



RUNNER UP







WORKSHOP ON SIMULATING HARDWARE CIRCUITS

20-11-2021

Using Tinker Cad and Proteus Software



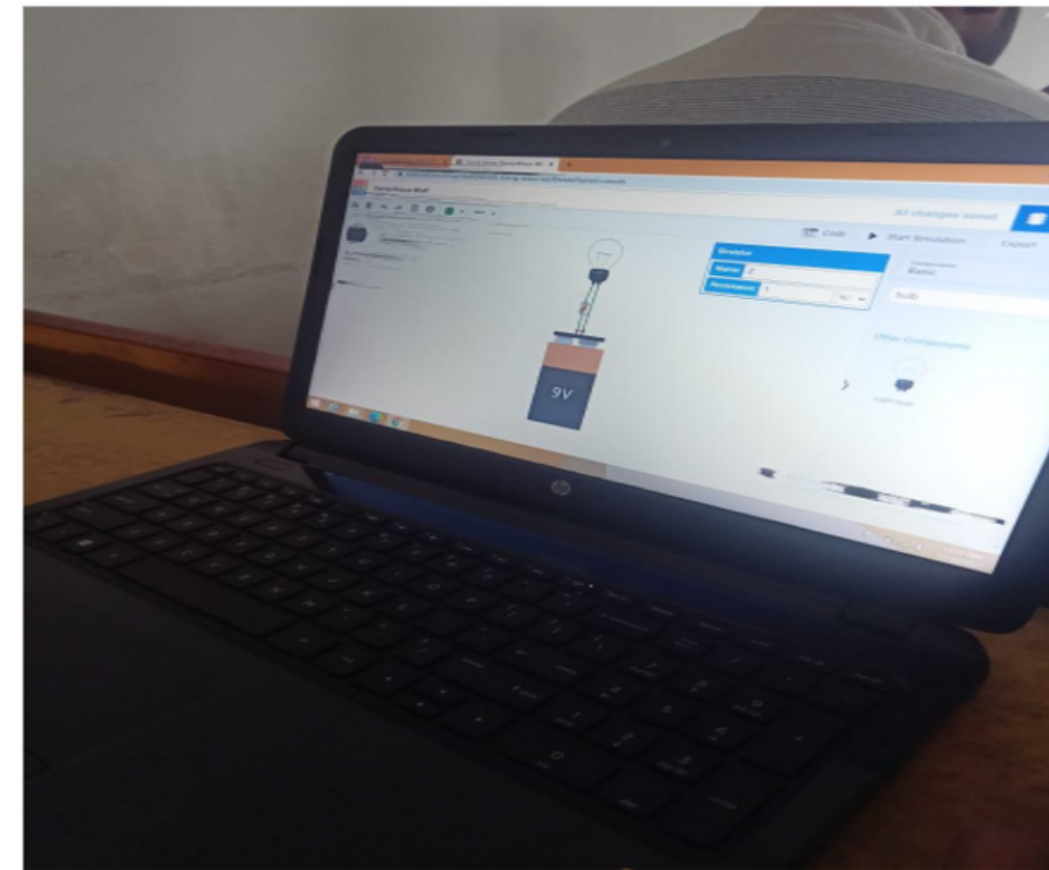

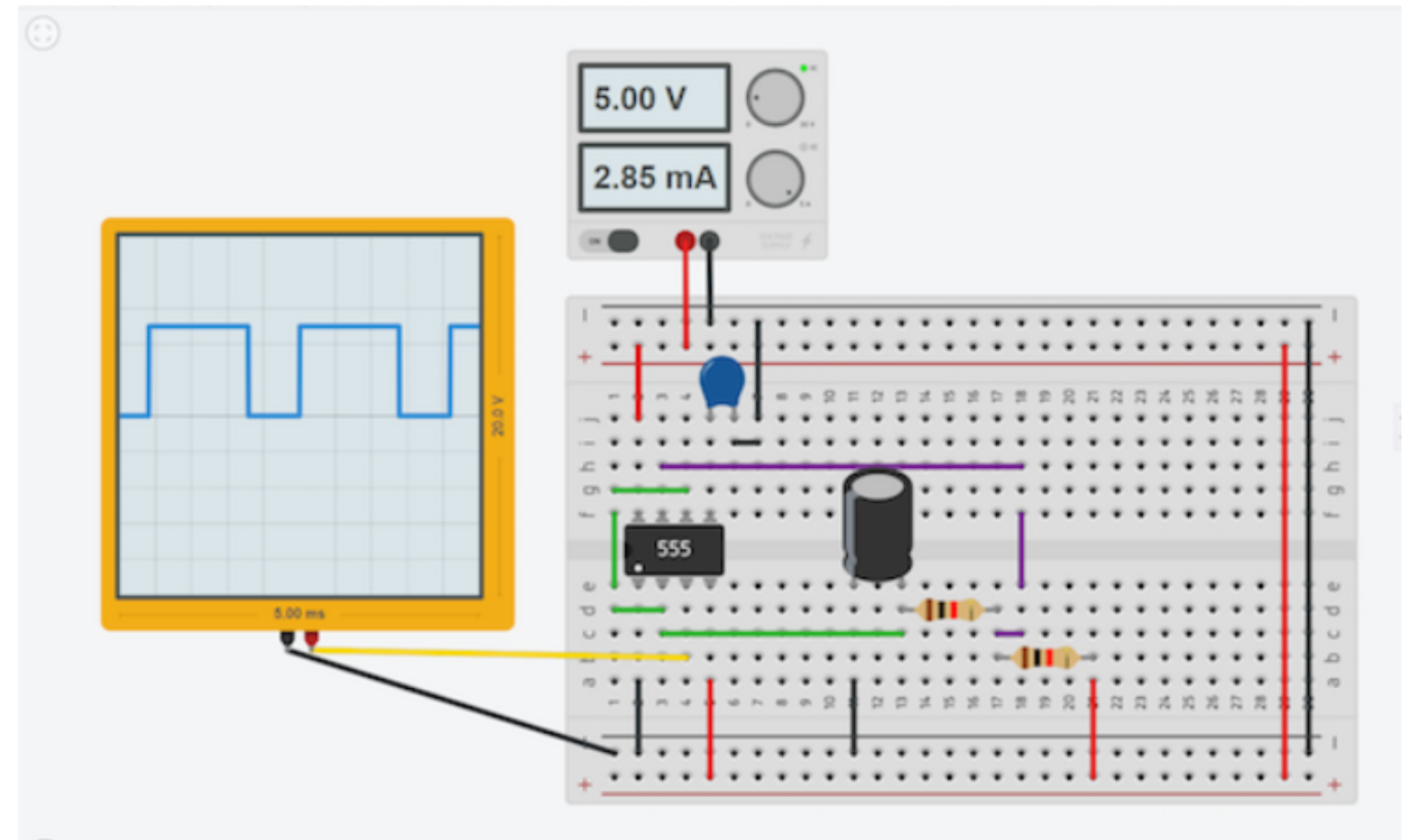
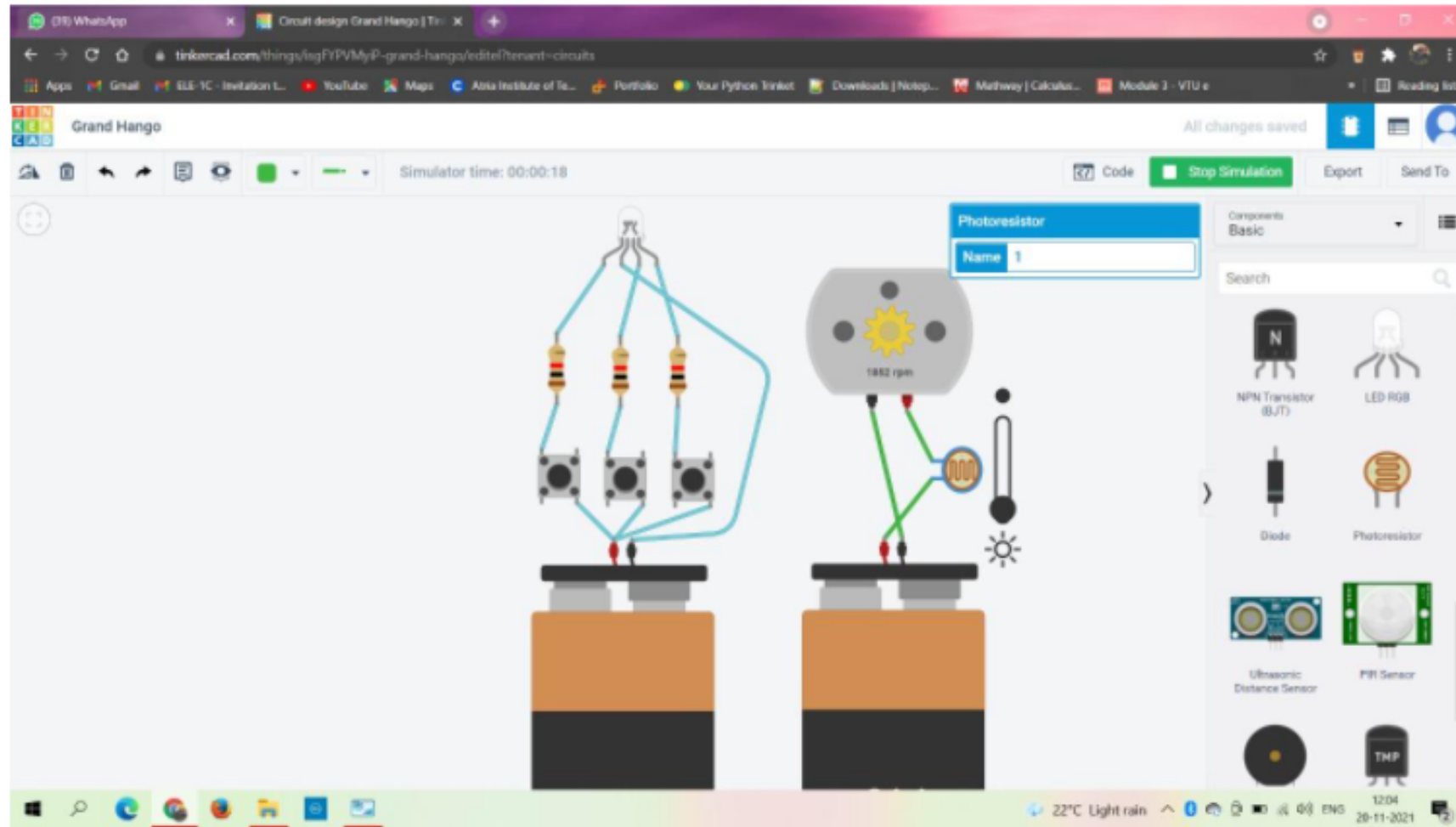



NATIONAL SCIENCE DAY

22-12-2020





**ATAIA**
INSTITUTE OF TECHNOLOGY

Department
OF
CS&E

CELEBRATES

PRESIDED BY



DR T N SREENIVASA
PRINCIPAL, ATRIA INSTITUTE OF TECHNOLOGY
FORMER ACADEMIC SENATE MEMBER ,VTU,BELAGAVI

CHIEF GUEST & SPEAKER



DR. HARISH PANT, FIE, MIET, CE
PARTNER COUNTRY HEAD - RESOLUS CONSULTING
MANAGING DIRECTOR - ADVANCE TECHNOLOGY

"National Science Day"

MAR 1ST 2021

Webinar on Future of STI: Impacts on Education, Skills and Work"

TIME: 10:30 AM

join us

<https://meet.google.com/fsp-wdbj-xqq>

Supported by



UNDER THE REGIS OF





CELEBRATION OF

National science Day 2021

HOSTED BY

Department OF CS&E

SPONSORED BY



KSCST

SUPPORTED BY



Events:
Mini Project Expo
Design Competition

Date:
01-March-2021

Time:
10:00 am

Convener:
Dr. Aishwarya.P
Dept of CS&E Atria.I.T

Coordinator:
Mrs. Hemalatha K N
Mr. Ravendra M





Key Takeaway

Find Your *Raman Effect!*

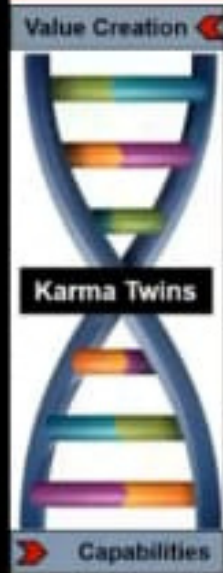

The Raman Effect – only one in a million of the scattered light particles, or photons, actually exhibits the change in wavelength when light goes through a medium.



The next Noble Prize?



Are you the next? 20..?



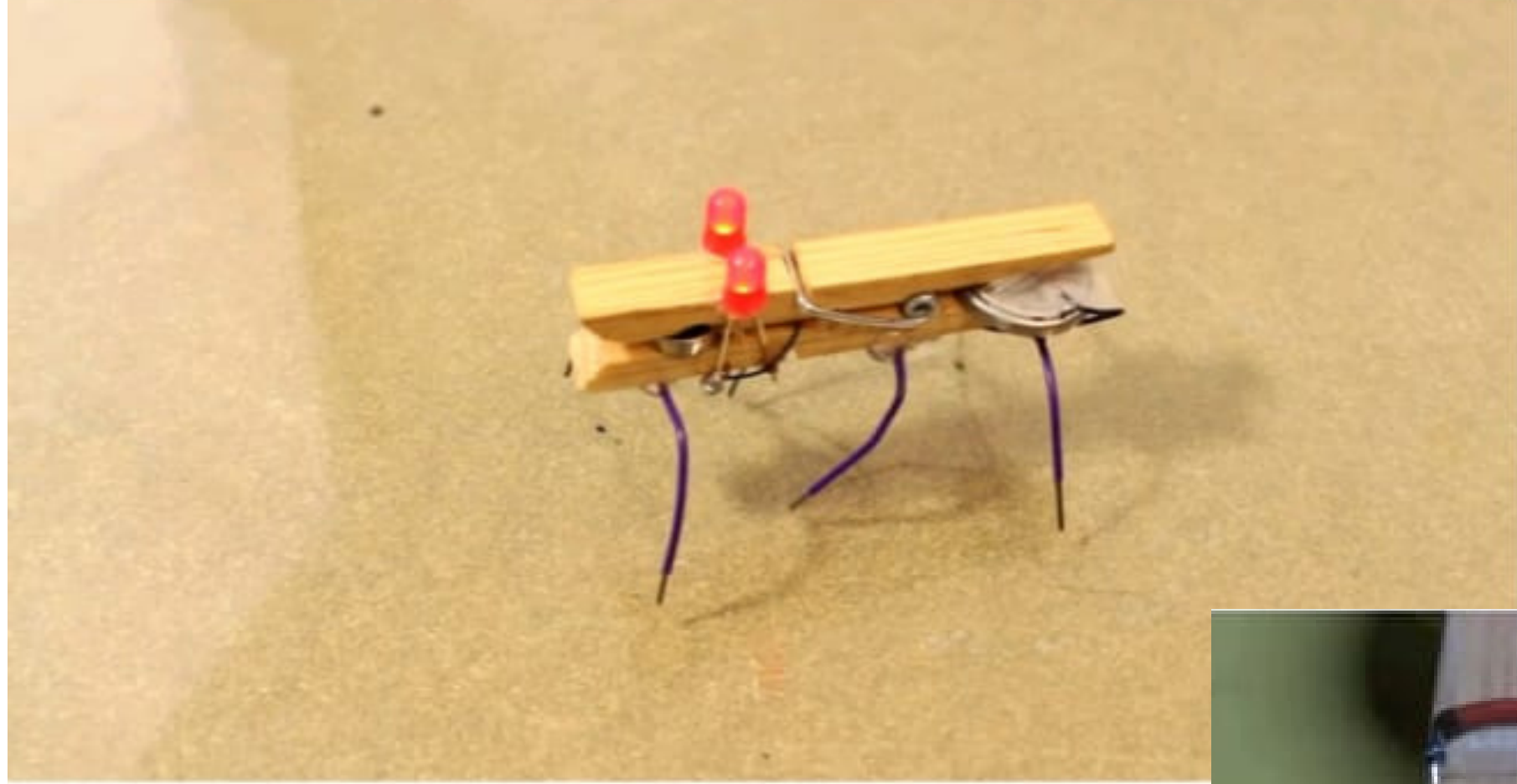





CODE CLUB

Community Of Developing Engineers

YEAR: 2019-2020





NATIONAL SCIENCE DAY

27-02-2019 to 28-02-2019





ASKB Campus, 1st Main, AGS Colony
Anandnagar, Bengaluru - 560024 Karnataka

All are cordially invited for the Inaugural of
National Science Day Carnival -2019
on February 27 & February 28, 2019

Inauguration between 9:00 AM and 10:30 AM on February 27, 2019
@ SEMINAR HALL

Chief Guest,
Sri. GangaRaju K M,
Scientist 'E',
CAIR, DRDO

Guests of Honor,
Sri. C.S.Kaushik Raju
Director, Technical
Atria Institute of Technology

Sri. Anand T.R
Advisor
Atria Institute of Technology

Presided by,

Dr.Aishwarya P
Chief Organizer
National Science Day

Dr. K.V.Narayanaswamy
Principal
Atria Institute of
Technology







STUDENT SOLAR AMBASSADORS

18-08-2019 to 02-10-2019





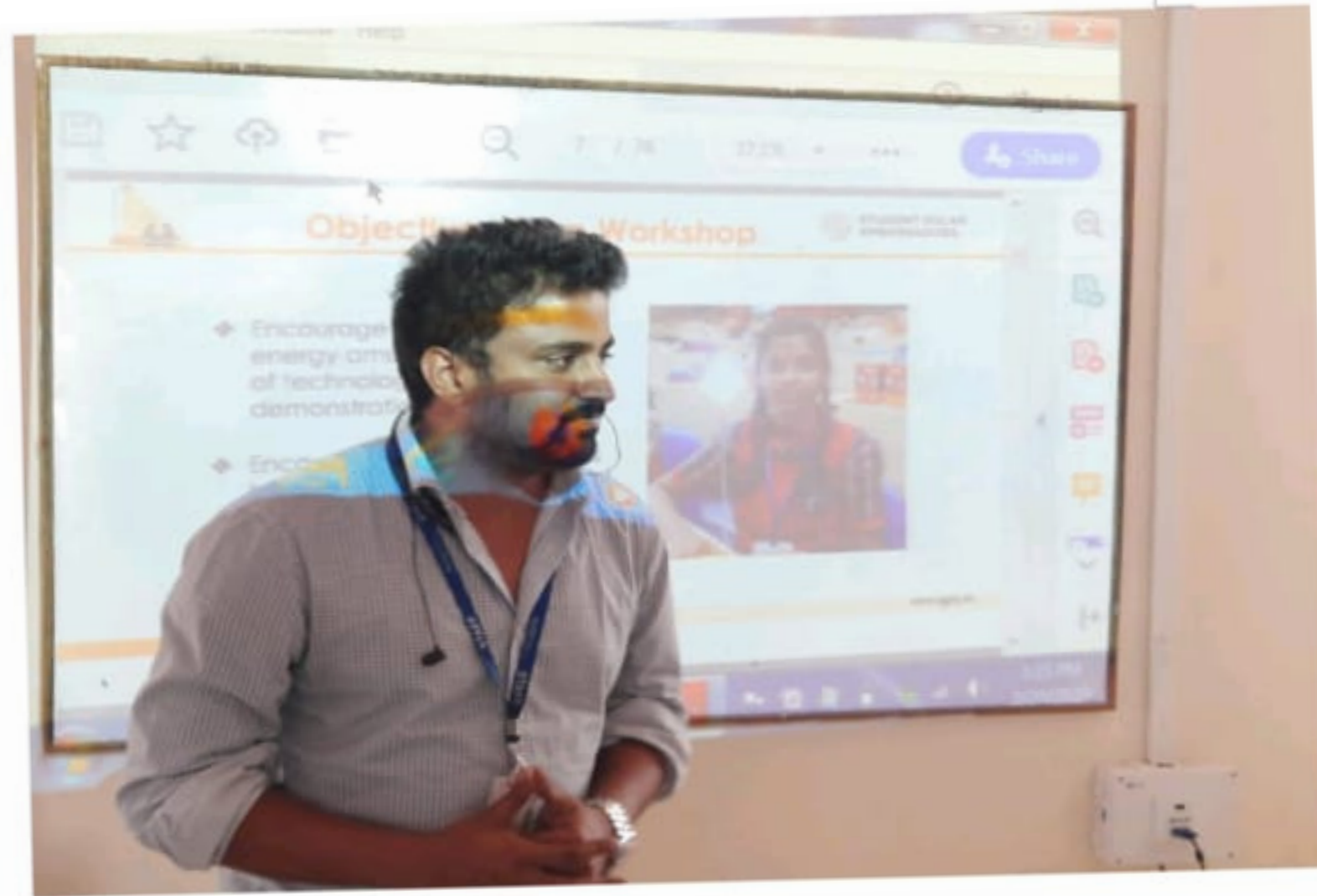

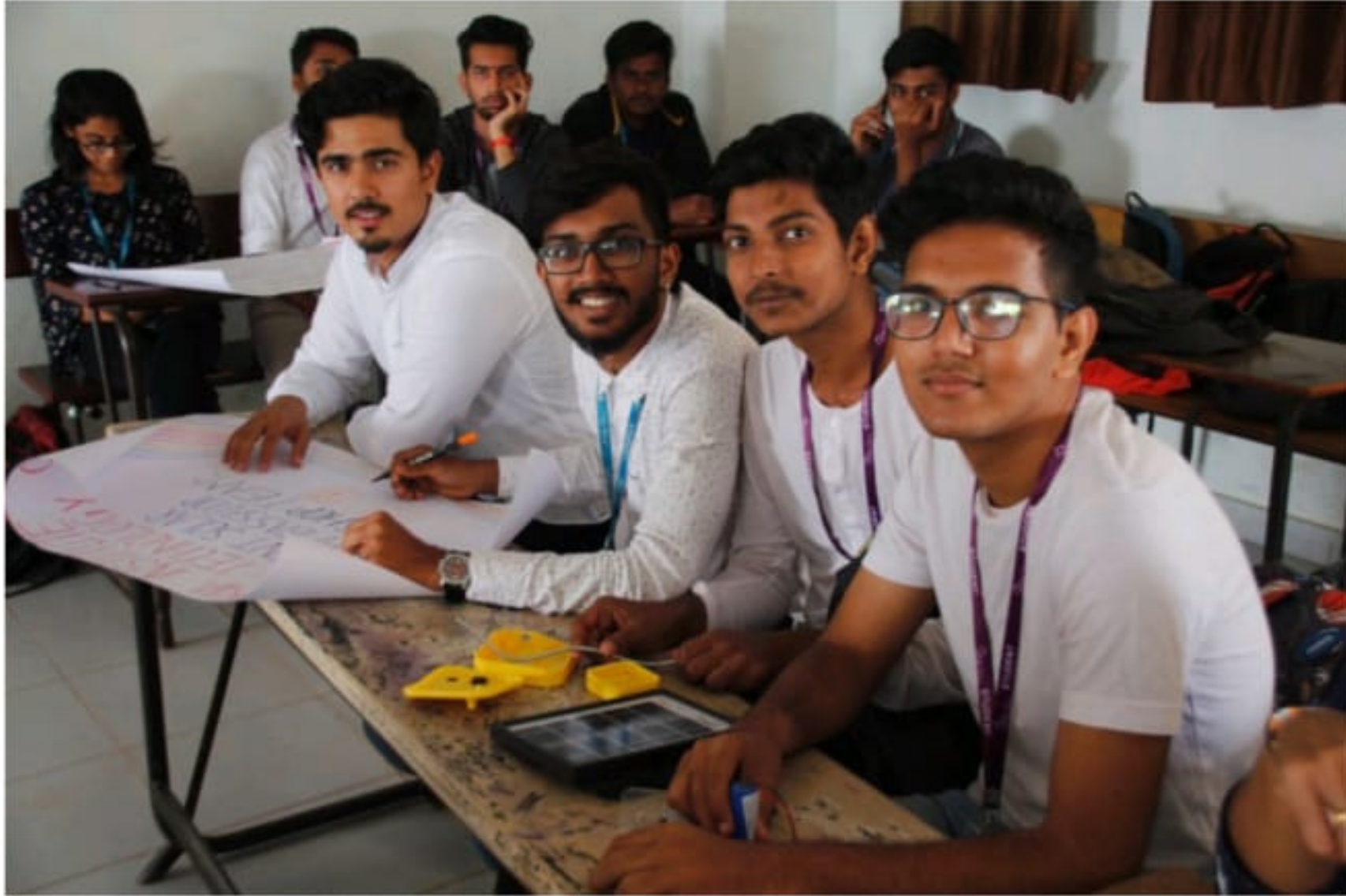



DEXTERIX

Annual Technical Fest

13-11-2019 to 14-11-2019







ATAIA
INSTITUTE OF TECHNOLOGY

DEXTERIX

NOVEMBER 13TH 14TH

MAKEATHON
24HR PROBLEM SOLVING EVENT

TECHNOVAGANZA
PROJECT EXPO
PRIZES UPTO 40000/-

CS ENGG.
TECH HUNT
TECH SAY
COMPETITIVE CODING
TECH LADDER
TECH FUNZY
VIR-TECX

IS ENGG.
HUMAN FOOSBALL
DART-IT
TECH CROSSWORD
ESCAPE ROOM
TIC-TAC-TOE
F.R.I.E.N.D.S

EC ENGG.
CIRCUITRIX
TECH CHARADES
TECH QUIZ

CRIMINALTY INQUEST
BEG BORROW STEAL
AIR CRASH

CIVIL ENGG. MECH ENGG.
GREEN BUILDING
CAD MANE
CIVIL TECH HUNT
SCRUTINIZE ENGG.
MINI FAIR
CRIC TRICK

TURTLE BIKEING
ASSEMBLY CYCLE
PSYCH CYCLE
CALL OF DUTY
TOOL HUNT
FOCUS ON

CONTACT-
UDAY NAG-7975116259 (CSE)
SHIV PRASAD-6361187551 (ISE)
ARYA GOWDA-9902366728 (ECE)
RAVINDRA-9742124257 (CIV)
SUDARSHAN-9886564974 (MECH)

@DEXTERIX2K19
WWW.DEXTERIX.COM

ATAIA
INSTITUTE OF TECHNOLOGY

ALL ARE CORDIALLY INVITED FOR THE INAUGURAL OF-

Dexterix '19

ON 13th AND 14th NOVEMBER 2019
INAUGURATION from 9:30 AM TO 10:30 AM ON 13th NOVEMBER 2019
@ MAIN SEMINAR HALL

Chief Guest

Prof. Viraj Kumar Ph.D
VISITING PROFESSOR,
DIVECHA CENTRE FOR CLIMATE CHANGE
IISc, BANGALORE

Guests Of Honor

Sri. Anand J. R
ADVISOR
ATRIA INSTITUTE OF TECHNOLOGY

Sri. Shaheem Rahiman
CEO
ATRIA CITY OF LEARNING

Sri. C. S. Kaushik Raju
DIRECTOR TECHNICAL
ATRIA GROUP OF INSTITUTIONS

Presided by,

DR. Aishwarya P
CONVENER
DEXTERIX-2K19

DR. K.V. Narayanswamy
PRINCIPAL
ATRIA INSTITUTE OF TECHNOLOGY

Curated By

Department Of Computer Science
And Engineering





NATIONAL MATHEMATICS DAY

22-12-2020





Hosted by
Department OF CS&E

Under the Aegis of
KSCST

ATRIA
INSTITUTE OF TECHNOLOGY

INVITES YOU

FOR THE VIRTUAL INAGURATION & CELEBRATION OF
"NATIONAL MATHEMATICS DAY"

"22 DECEMBER 2020"
09:00AM to 10:00AM

Welcome address by

Dr. Aishwarya. P
Professor & Head
Department of CS&E.

Keynote Speaker

Dr. Dinesh P A
Associate Professor
Department of Mathematics
M S Ramaiah Institute of Technology.

Presided by

Dr. K V Narayanaswamy
Principal
Atria Institute of Technology.

10:00 AM ONWARDS : BLENDED MODE OF COMPETITIONS TO STUDENTS

Link for the event <https://meet.google.com/cnh-dnke-oeg>

ATRIA
INSTITUTE OF TECHNOLOGY

Department OF CS&E

DEPARTMENT OF COMPUTER SCIENCE & ENGINEERING

PRESENTS
EXPERT TALK
ON
"MATHEMATICAL MODELS OF ABSTRACT COMPUTING MACHINES"
CONTEXT FREE GRAMMARS & SIMPLIFICATION
SPEAKER

NATIONAL MATHEMATICS DAY
22 DECEMBER 2020
2:00 PM - 4:00 PM



**OPEN TO ALL 5-SEM CS/IS
BRANCH STUDENTS**

Mrs. Anitha Sandeep
Assistant Professor
Department of CS&E,
RV College of Engineering



Session Link <https://meet.google.com/cnh-dnke-oeg>



cnh-dnke-oeg (2020-12-21 at 19:31 GMT-8)

NATIONAL Mathematics DAY-2020
Minute – to – Minute Event Flow

Date:22/12/2020

TIME	EVENT
09:00AM - 09:05AM	Arrival of the dignitaries through google Link
09:05AM - 09:10AM	Welcoming Address by Dr.Aishwarya P
09:10AM - 09:20AM	Presidential address by Dr. K V Narayanaswamy
09:20AM - 09:25AM	Introduction of Chief Guest by Dr. Nalinakshi N
09:25 AM- 10:00AM	Keynote Session by chief guest
10:00AM - 10:05AM	Vote of thanks -Prof. vasanthi
10:05AM - 10:10AM	Brief information of events

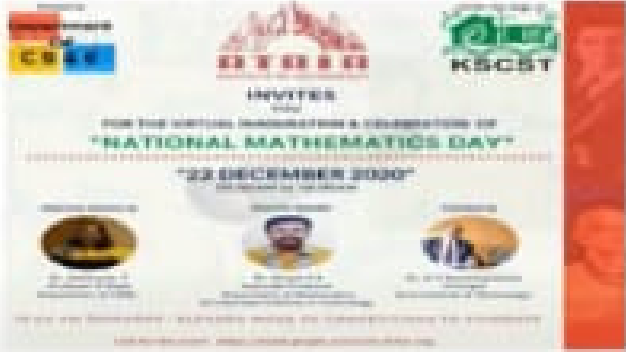

23:28 / 1:05:02

CC





CODE CLUB

Community Of Developing Engineers

YEAR: 2018-2019





DEXTERIX

Annual Technical Fest

02-11-2018 to 03-11-2018





Atria Institute of Technology

DEXTERIX'18

2nd - 3rd of NOV

QUICK SURVEY
Don't count the minutes, make every minute count

STRUCTURE CAPTURE
keep calm and click on

TOWER BUILDER
taller, stronger, faster

BRIDGE IT
go heavy or go home

CADD MANE
dwg

QUIZ
use your brain for the next level

CONTACT US : Ranjitha V 9632277672 Sai Sanjith 9620951439 Sanjana K 9620697538

PosterMyWall.com

dexterix2k18 fb.com/code.ait

DEXTERIX 2K18

2ND & 3RD NOVEMBER

- > TERRAIN SURVIVAL
- > TOOL TANTRA
- > ASSEMBLY ADVENTURE
- > ROAR
- > CYCLE RACE
- > GO NUTS

Further Details :- www.dexterix.com

dexterix2k18 RAGHU - 9686519241 YATHISH - 9481307798



ISE

Atria Institute of Technology
2ND & 3RD NOVEMBER

DEXTERIX
2K18

BLIND CODING BAKAASURA
START UP PITCH CYCLE ತುಳಿ C ಕಲಿ
WEB DESIGN WATER KABADDI

CONTACT | Surya.M : 7892787269
Nagendra : 8971528181
Arvind : 9945613932

QR Code

Atria INSTITUTE OF TECHNOLOGY
DEPT. OF ECE

2ND & 3RD NOVEMBER

>>>> CRIMINALITY INQUEST
OUR CASE YOUR CHASE

>>>> SALVAGE SEIZE WIN
WE NEED WHAT YOU NEED

>>>> ATRIA TRIBUNAL
HONOR-BELLY THE BEST

>>>> BIONIC DARTING
FROM TO THE METAL

>>>> RAM ROM EVOKE
ACCESS THY BRAIN
GIVE US THOU NAME

>>>> CIRCUITRIX
UNRAVEL THE MYSTERY
OF CIRCUITS

F.U.S.E

Further Details :- www.dexterix.com

CONTACT:-
SAMPATH-9892712798
PRAMATH- 7798889998

Instagram: dexterix2k18 Hype

QR Code



